

Master Program in *Data Science and Business Informatics*

# Statistics for Data Science

Lesson 23 - Statistical decision theory

Salvatore Ruggieri

Department of Computer Science

University of Pisa, Italy

[salvatore.ruggieri@unipi.it](mailto:salvatore.ruggieri@unipi.it)

- Question: which hypothesis is the most probable given the observed data?
  - ▶ Maximum Likelihood Estimation (MLE) is a frequentist method:

$$\theta_{MLE} = \arg \max_{\theta} P(X_1 = x_1, \dots, X_n = x_n | \theta) = \arg \max_{\theta} \prod_{i=1}^n f_{\theta}(x_i)$$

- ▶ Maximum a Posteriori (MAP) is a Bayesian method (requires prior distribution):

$$\theta_{MAP} = \arg \max_{\theta} P(\theta | X_1 = x_1, \dots, X_n = x_n) = \arg \max_{\theta} P(X_1 = x_1, \dots, X_n = x_n | \theta) P(\theta)$$

- since by the Bayes theorem

$$P(\theta | X_1 = x_1, \dots, X_n = x_n) = \frac{P(X_1 = x_1, \dots, X_n = x_n | \theta) P(\theta)}{P(X_1 = x_1, \dots, X_n = x_n)}$$

- ▶ MAP = MLE if prior is uniform

# Classification/concept learning

- $X = (W, C)$  where  $W$  are predictive features and  $C$  class, with  $\text{support}(C) = \{0, 1, \dots, n_C - 1\}$
- $x_1, \dots, x_n$  are observations (training set), with  $x_i = (w_i, c_i)$  for  $i = 1, \dots, n$
- $\theta \in \Theta$  with  $\Theta$  hypothesis space (parameters of ML model) with  $f_\theta$  joint density of  $W, C$
- Question: which hypothesis (parameters) is the most probable given the observed data?
  - ▶  $\theta_{MLE} = \arg \max_{\theta} \ell(\theta) = \arg \min_{\theta} -\ell(\theta) = \arg \min_{\theta} \sum_{i=1}^n -\log f_\theta(x_i)$
  - ▶  $f_\theta(x_i) = f_\theta(w_i, c_i) = f_\theta(c_i|w_i)f_\theta(w_i)$
  - ▶  $\theta_{MLE} = \arg \min_{\theta} \sum_{i=1}^n -\log f_\theta(c_i|w_i) - \sum_{i=1}^n \log f_\theta(w_i)$
  - ▶ Assuming  $\theta \perp\!\!\!\perp W$ , we have  $f_{\theta_1}(w_i) = f_{\theta_2}(w_i)$ , and then:

$$\theta_{MLE} = \arg \min_{\theta} \sum_{i=1}^n -\log f_\theta(c_i|w_i)$$

- ▶ How to compute  $\theta_{MLE}$ ? Closed form, brute force enumeration of  $\theta \in \Theta$ , heuristic search, ...
- $f_\theta(c|w) = P(C = c|W = w, \theta)$  is called a **probabilistic classifier** learned/trained from  $x_1, \dots, x_n$

# Probabilistic classifiers: examples

- Logistic regression
- k-Nearest Neighbors (k-NN)
- Decision trees
- Neural networks
- Naive Bayes  $P(C = c_0 | W = w) = P(C = c_0) \prod_i P(W_i = w_i | C = c_0) / P(W = w)$   
assuming  $P(W = w | C = c_0) = \prod_i P(W_i = w_i | C = c_0)$
- Ensembles
- Gradient boosting
- ...
- More classifiers at the Data Mining course

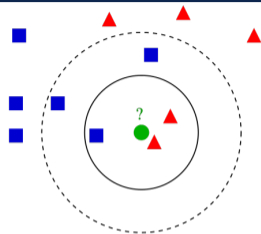

Survival of passengers on the Titanic

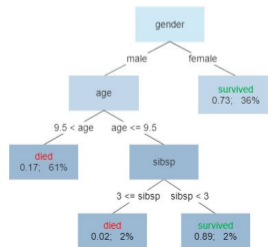

See R script

# MLE and KL divergence/Cross-Entropy

$$\theta_{MLE} = \arg \min_{\theta} \sum_{i=1}^n -\log f_{\theta}(c_i | w_i)$$

- Assume data is generated from  $f_{\theta_{TRUE}}$ , i.e.,  $(W, C) \sim f_{\theta_{TRUE}}$
- We compute:

$$\theta_{MLE} = \arg \min_{\theta} \sum_{i=1}^n (-\log f_{\theta}(c_i | w_i) + \log f_{\theta_{TRUE}}(c_i | w_i)) = \arg \min_{\theta} \frac{1}{n} \sum_{i=1}^n \log \frac{f_{\theta_{TRUE}}(c_i | w_i)}{f_{\theta}(c_i | w_i)}$$

$$\xrightarrow{n \rightarrow \infty} \text{LLN} \arg \min_{\theta} E_{(W,C) \sim f_{\theta_{TRUE}}} \left[ \log \frac{f_{\theta_{TRUE}}(C|W)}{f_{\theta}(C|W)} \right] = \arg \min_{\theta} D(\theta_{TRUE} \| \theta) = \arg \min_{\theta} H(\theta_{TRUE}; \theta)$$

- Asymptotically: ML maximization = KL divergence minimization = Cross-entropy minimization

# Classification/concept prediction

- Question: which is the most probable prediction for given  $w$  and  $\theta$ ?
- Classification/concept prediction problem
  - ▶ **Problem:** given  $\theta \in \Theta$  and  $W = w$ , what is the most probable  $C = c$ ? i.e.:

$$\arg \max_c P(C = c, W = w | \theta)$$

which is equivalent, assuming  $\theta \perp\!\!\!\perp W$ , to:

$$\arg \max_c P(C = c | W = w, \theta) = \arg \max_c f_\theta(c | w)$$

- **Bayes decision rule**  $y_\theta^*(w) = \arg \max_c f_\theta(c | w)$  *[or simply,  $y^*$ ]*

## Theorem (Bayes decision rule is optimal)

Fix  $\theta \in \Theta$ . For any decision rule  $y_\theta^+ : \mathbb{R}^{|W|} \rightarrow \{0, \dots, n_C - 1\}$ :

$$P(y_\theta^*(W) \neq C) \leq P(y_\theta^+(W) \neq C)$$

**Proof.**  $P(y_\theta^*(W) = C) = E[\mathbb{1}_{y_\theta^*(W)=C}] = E[E_C[\mathbb{1}_{y_\theta^*(W)=C} | W = w]] \geq$   
 $\geq E[E_C[\mathbb{1}_{y_\theta^+(W)=C} | W = w]] = E[\mathbb{1}_{y_\theta^+(W)=C}] = P(y_\theta^+(W) = C)$

# Decision boundary

Logistic Regression

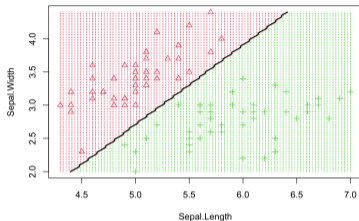

kNN (k = 1)

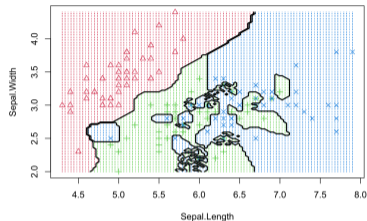

Decision Tree

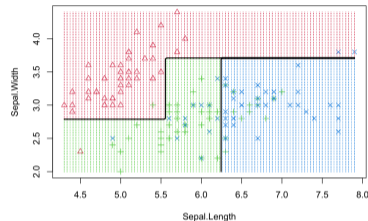

- A decision boundary for a decision rule  $y_{\theta}^{+}(\cdot)$  is the region  $w \in \mathbb{R}^{|W|}$  such that  $y_{\theta}^{+}(w)$  could admit as possible answers two or more classes
- For  $y_{\theta}^{*}$ , it is the region  $w \in \mathbb{R}^{|W|}$  such that  $\arg \max_c f_{\theta}(c|w)$  is not unique.
- For  $y_{\theta}^{*}$  and  $n_C = 2$ , it is the region  $w \in \mathbb{R}^{|W|}$  such that  $f_{\theta}(1|w) = 0.5$ .

See R script

# Bayes optimal predictions

- Question: which is the most probable prediction given  $w$ ?
- Possible answer:  $\arg \max_c P(C = c | W = w, \theta_{MAP}) = y_{\theta_{MAP}}^*(w)$
- No, we can do better
  - ▶ Let  $\Theta = \{\theta_1, \theta_2, \theta_3\}$  and
    - $P(\theta_1 | X_1 = x_1, \dots, X_n = x_n) = 0.4$
    - $P(\theta_2 | X_1 = x_1, \dots, X_n = x_n) = P(\theta_3 | X_1 = x_1, \dots, X_n = x_n) = 0.3$
  - ▶ Hence  $\theta_{MAP} = \theta_1$
  - ▶ Assume  $f_{\theta_1}(1|w) = 1$  and  $f_{\theta_2}(0|w) = f_{\theta_3}(0|w) = 1$
  - ▶ Hence, prediction 0 has the largest probability, whilst prediction of  $\theta_{MAP}$  is 1
- **Problem:** given  $W = w$ , what is the most probable  $C = c$ ? i.e.:

$$\arg \max_c P(C = c | W = w, X_1 = x_1, \dots, X_n = x_n)$$

## Bayes optimal prediction

$$\arg \max_c \sum_{\theta \in \Theta} f_{\theta}(c|w) P(\theta | X_1 = x_1, \dots, X_n = x_n)$$



# Probabilistic classifier

- Probabilistic classifier:  $f_{\theta}(c|w) \in [0, 1]$  with  $\sum_c f_{\theta}(c|w) = 1$ :
  - ▶ learned from  $x_1, \dots, x_n$
  - ▶ predicted probabilities  $(p_0, \dots, p_{n_c-1})$  with  $p_i = f_{\theta}(i|w)$
  - ▶ most probable class  $y_{\theta}^* = \arg \max_c f_{\theta}(c|w)$
  - ▶ confidence (of most probable class)  $p_{\theta}^* = \max_c f_{\theta}(c|w)$
- Unnormalized classifier:  $uc_{\theta}(c|w) \in \mathbb{R}$ 
  - ▶ unnormalized values  $(v_0, \dots, v_{n_c-1})$  with  $v_i = uc_{\theta}(i|w)$
  - ▶ normalization:

$$\text{softmax}((v_0, \dots, v_{n_c-1})) = \left( \frac{e^{v_0}}{\sum_i e^{v_i}}, \dots, \frac{e^{v_{n_c-1}}}{\sum_i e^{v_i}} \right)$$

- ▶ binary classes  $(v_0 = 0, v_1)$ :

$$\text{softmax}((0, v_1)) = (1 - z, z) \quad \text{where } z = \text{sigmoid}(v_1) = \text{inv.logit}(v_1) = \frac{1}{1 + e^{-v_1}}$$

- ▶  $\text{softmax}(\mathbf{v} + c) = \text{softmax}(\mathbf{v})$
- ▶  $\frac{d}{d\mathbf{v}} \text{softmax}(\mathbf{v}) = \text{softmax}(\mathbf{v})(1 - \text{softmax}(\mathbf{v}))$

# Example: Perceptron with sigmoid activation

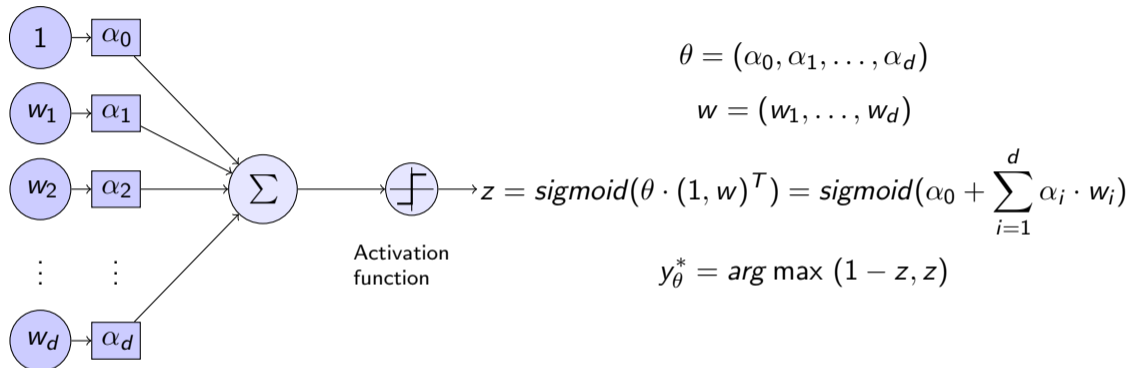

inputs weights

- Difference with logistic regression?
  - ▶ Weights calculated differently (MLE vs gradient descent)
  - ▶ Perceptron is parametric to **activation functions**
  - ▶ Perceptron with sigmoid activation = Logistic regression

# Binary classification/concept learning

- $X = (W, C)$  where  $W$  are predictive features and  $C$  class, with  $\text{support}(C) = \{0, 1\}$
- $x_1, \dots, x_n$  are observations (training set), with  $x_i = (w_i, c_i)$
- **Definition.** Score function:  $s_\theta(w) = f_\theta(1|w) = P(C = 1|W = w, \theta)$ 
  - ▶ predicted probabilities  $(1 - s_\theta(w), s_\theta(w))$
  - ▶ confidence (of most probable class):  $\max\{1 - s_\theta(w), s_\theta(w)\}$
  - ▶  $f_\theta(x_i) = f_\theta((w_i, c_i)) = f_\theta(c_i|w_i)f_\theta(w_i) = s_\theta(w_i)^{c_i}(1 - s_\theta(w_i))^{(1-c_i)}P(w_i)$
- MLE estimation

$$\theta_{MLE} = \arg \min_{\theta} \sum_{i=1}^n -\log f_\theta(c_i|w_i) = \arg \min_{\theta} \frac{1}{n} \sum_{i=1}^n -c_i \log s_\theta(w_i) - (1 - c_i) \log (1 - s_\theta(w_i))$$

- Cross-entropy loss or log-loss:

$$\ell_\theta(c, w) = \begin{cases} -\log s_\theta(w) & \text{if } c = 1 \\ -\log(1 - s_\theta(w)) & \text{if } c = 0 \end{cases}$$

- MLE maximization = Log-loss minimization

$$\theta_{MLE} = \arg \min_{\theta} \frac{1}{n} \sum_{i=1}^n \ell_\theta(c_i, w_i)$$

# MLE and ERM for classification/concept learning

## Empirical risk minimization

Let  $\ell_\theta : \{0, \dots, n_C - 1\} \times \mathbb{R}^{|W|} \rightarrow \mathbb{R}_{\geq 0}$  be a loss function.

$$\theta_{ERM} = \arg \min_{\theta} \frac{1}{n} \sum_{i=1}^n \ell_\theta(c_i, w_i)$$

- MLE is ERM with Log-loss  $\ell_\theta(c, w) = -\log f_\theta(c|w) = \log \frac{1}{P(c|w, \theta)}$
- 0-1 loss  $\ell_\theta(c, w) = \mathbb{1}_{y_\theta^+(w) \neq c}$  where  $y_\theta^+(w) \in \{0, \dots, n_C - 1\}$  is a decision rule
  - ▶ not convex, not differentiable, optimization problem is NP-hard
- $L_p$  error loss for binary classifiers  $\ell_\theta(c, w) = |s_\theta(w) - c|^p$ 
  - ▶ absolute error loss or  $L_1$ :  $|s_\theta(w) - c|$
  - ▶ squared error loss or  $L_2$  or Brier score:  $(s_\theta(w) - c)^2$

# Loss functions and classifiers

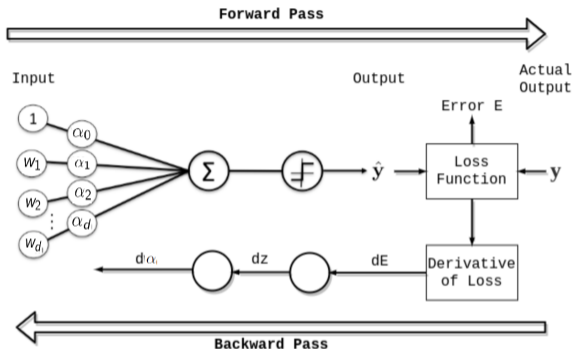

- Gradient of loss function determines updates of weights  $\alpha_0, \dots, \alpha_d$  in the direction of improving the loss (Backpropagation)
- Similar idea in ensemble of decision trees, where each one improves on the error of the previous one (Gradient boosting trees)

# Loss functions and margin

- Binary classes  $C = \{-1, 1\}$ , unnormalized scores  $s_\theta(w) \in \mathbb{R}$ 
  - ▶ Bayes decision rule becomes:  $y_\theta^* = \text{sgn}(s_\theta(w))$

- Margin defined as

$$m = c \cdot s_\theta(w)$$

- ▶ Margin  $> 0$  if prediction is correct (i.e.,  $s_\theta(w) \geq 0$  and  $c = 1$ , or if  $s_\theta(w) < 0$  and  $c = -1$ )
  - ▶ Loss minimization equivalent to margin maximization
- **Margin-based loss:** Loss function  $\ell_\theta(c, w)$  that can be written as  $\phi(m)$ :
  - ▶ 0-1 loss:  $\phi(m) = \mathbb{1}_{m \leq 0}$
  - ▶ Logistic log-loss:  $\phi(m) = \log_2(1 + e^{-m})$
  - ▶  $L_2$  loss:  $\phi(m) = (1 - m)^2$
  - ▶ SVM/Hinge loss:  $\phi(m) = \max\{0, 1 - m\}$
  - ▶ AdaBoost/Exponential loss:  $\phi(m) = e^{-m}$
- Methods for margin maximization exists for a convex margin-based loss
  - ▶ that also provide bounds on 0-1 loss
  - ▶ that encode regularizations in the margin-based loss

See R script

# MSE and the bias-variance trade-off

- Squared error loss  $\theta_{ERM} = \arg \min_{\theta} MSE$ , where the Mean Squared Error is:

$$MSE = \frac{1}{n} \sum_{i=1}^n (s_{\theta}(w_i) - c_i)^2$$

- ▶ Why named *MSE*? Because  $MSE \xrightarrow{n \rightarrow \infty} LLN E_{(W,C) \sim f_{\theta_{TRUE}}} [(s_{\theta}(W) - C)^2]$
- ▶ MSE approximates the Mean Squared-Error over the population
- ▶ Notice: in MSE for estimators  $C$  was a constant (parameter)
- Assumes that  $C = D + \epsilon$ , where  $E[\epsilon] = 0$ 
  - ▶ Observed class labels  $c_i$  include some noise w.r.t. true labels, i.e.,  $c_i = d_i + \epsilon_i$
- Decomposition of MSE:

$$E[MSE] = Var(s_{\theta}(W)) + E[s_{\theta}(W) - C]^2 + Var(\epsilon)$$

- ▶  $Var(\epsilon)$  irreducible error
- ▶  $E[s_{\theta}(W) - C]^2$  is *Bias*<sup>2</sup>. Minimized by interpolating training data, but with high variance.
- ▶  $Var(s_{\theta}(W))$  variance of the scores. Minimized by a constant score, but with high bias.

# Loss functions and risk

Consider the squared error loss. For  $n \rightarrow \infty$ :

$$\theta_{ERM} = \arg \min_{\theta} \frac{1}{n} \sum_{i=1}^n (s_{\theta}(w) - c_i)^2 \rightarrow \arg \min_{\theta} E_{(W,C) \sim f_{\theta_{TRUE}}} [(s_{\theta}(W) - C)^2]$$

## Risk (or Expected Prediction Error EPE)

The risk w.r.t. a loss function  $\ell_{\theta}$  is  $R(\theta_{TRUE}, \theta) = E_{(W,C) \sim f_{\theta_{TRUE}}} [\ell_{\theta}(C, W)]$ .

**Definition.** A loss function is a **proper scoring rule** if:

$$\theta_{TRUE} = \arg \min_{\theta} R(\theta_{TRUE}, \theta)$$

- For log-loss,  $R(\theta_{TRUE}, \theta) = D(\theta_{TRUE} \parallel \theta) \geq 0$  and  $D(\theta_{TRUE} \parallel \theta) = 0$  iff  $\theta = \theta_{TRUE}$
- Log-loss and  $L_2$  are proper scoring rules, whilst  $L_1$  is not
  - ▶ Hence, for squared error loss, for  $n \rightarrow \infty$ ,  $\theta_{ERM} \rightarrow \theta_{TRUE}$



# Bayes optimal classifier for 0-1 loss

- Risk of 0-1 loss, binary case. Let  $\eta(w) = P_{\theta_{TRUE}}(C = 1|W = w)$ , and  $y_{\theta}^+$  a decision rule.

$$\begin{aligned} E_{(W,C) \sim f_{\theta_{TRUE}}} [\mathbb{1}_{y_{\theta}^+(W) \neq C}] &= E_W[E_C[\mathbb{1}_{y_{\theta}^+(W) \neq C} | W]] \\ &= E_W[P(C = 1 | W) \cdot \mathbb{1}_{y_{\theta}^+(W) \neq 1} + P(C = 0 | W) \cdot \mathbb{1}_{y_{\theta}^+(W) \neq 0}] \\ &= E_W[\eta(W) \cdot \mathbb{1}_{y_{\theta}^+(W) = 0} + (1 - \eta(W)) \cdot \mathbb{1}_{y_{\theta}^+(W) = 1}] \\ &\geq E_W[\min\{\eta(W), 1 - \eta(W)\}] \\ &= E_W[\eta(W) \cdot \mathbb{1}_{y_{\theta_{TRUE}}^*(W) = 0} + (1 - \eta(W)) \cdot \mathbb{1}_{y_{\theta_{TRUE}}^*(W) = 1}] \\ &= E_{(W,C) \sim f_{\theta_{TRUE}}} [\mathbb{1}_{y_{\theta_{TRUE}}^*(W) \neq C}] \quad \text{Bayes error rate} \end{aligned}$$

where  $y_{\theta_{TRUE}}^*$  is the **Bayes optimal classifier** (or **Bayes rule**):

$$y_{\theta_{TRUE}}^*(w) = \begin{cases} 1 & \text{if } \eta(w) \geq 1/2 \\ 0 & \text{if } \eta(w) < 1/2 \end{cases}$$

- Hence,  $\arg \min_{y_{\theta}^+} E_{(W,C) \sim f_{\theta_{TRUE}}} [\mathbb{1}_{y_{\theta}^+(W) \neq C}] = y_{\theta_{TRUE}}^*$
- Optimal decision boundary:  $\eta(w) = 1/2$

See R script

# Bayes optimal classifier

$$\eta(w) = P_{\theta_{TRUE}}(C = 1|W = w)$$

- $\eta()$  is unknown! (unless we are controlling data generation)
- **Plug-in rule:** use  $\hat{\eta}(w) = f_{\theta}(c|w) = P_{\theta}(C = 1|W = w)$  as an estimate of  $\eta(w)$
- Naive Bayes  $P(C = c_0|W = w) = P(C = c_0) \prod_i P(W_i = w_i|C = c_0)/P(W = w)$   
assuming  $P(W = w|C = c_0) = \prod_i P(W_i = w_i|C = c_0)$ 
  - ▶ Naive Bayes estimates  $\eta(w)$  from empirical distribution of  $x_1, \dots, x_n$
  - ▶ and assuming independence of features

- 1-NN asymptotically converges ( $|\theta| \rightarrow \infty$ ) to risk: [Cover and Hart (1967)]

$$r \leq E_{(W,C) \sim f_{\theta_{TRUE}}} [\mathbb{1}_{y_{\theta}^{1-NN}(W) \neq C}] \leq 2r(1 - r) \leq 2r$$

where  $r$  is the Bayes error rate.

- Bayes optimal classifier is optimal also for squared loss [Prove it]
  - ▶ Square loss is convex and differentiable (better use for optimization)

# Maximum and Bayes risks

## Risk

The risk w.r.t. a loss function  $\ell$  is  $R(\theta_{TRUE}, \theta) = E_{(W,C) \sim f_{\theta_{TRUE}}} [\ell_{\theta}(C, W)]$ .

**Definition.** The maximum risk is

$$\bar{R}(\theta) = \sup_{\theta_{TRUE}} R(\theta_{TRUE}, \theta)$$

A classifier  $f_{\theta'}$  such that  $\bar{R}(\theta') = \inf_{\theta} \bar{R}(\theta)$  is called a **minimax rule**.

**Definition.** Let  $f(\theta_{TRUE})$  be a prior for  $\theta_{TRUE}$ . The Bayes risk is

$$r(\theta) = \int R(\theta_{TRUE}, \theta) f(\theta_{TRUE}) d\theta_{TRUE}$$

A classifier  $f_{\theta'}$  such that  $r(\theta') = \inf_{\theta} r(\theta)$  is called a **Bayes rule**.

# Classifiers in R: Libraries

**The Caret package** (Classification And REgression Training)

**rpart** (Recursive PARTitioning for classification, regression and survival trees)

**randomForest** (Breiman and Cutler's Random Forests for classification and regression)

**lightgbm** (LIGHT Gradient Boosting Machine)

**fastai** (Fast and accurate neural networks training)

**kernlab** (KERNel-Based Machine Learning LAB)

**rminer** (Data mining classification and regression methods)

...

**See R script**

# Reject option in binary classification

$$\eta(w) = P_{\theta_{TRUE}}(C = 1|W = w)$$

**Bayes optimal classifier** (or **Bayes rule**):

$$y_{\theta_{TRUE}}^*(w) = \begin{cases} 1 & \text{if } \eta(w) \geq 1/2 \\ 0 & \text{if } \eta(w) < 1/2 \end{cases}$$

- Recall:  $P(y_{\theta}^*(w) \neq C) = \min \{\eta(w), 1 - \eta(w)\}$
- If  $\eta(w) \approx 1/2$ , we might just as well toss a coin to make a decision
- This motivates the introduction of a reject option for classifiers
  - ▶ reject, or abstain, expressing doubt or uncertainty in decisions
  - ▶ relevant in practice (e.g., to understand the cases where a classifier performs poorly),
  - ▶ relevant ethically for socially sensitive decision tasks (e.g., credit scoring, disease prediction, CV screening, etc.)

# Reject option in binary classification

$$\eta(w) = P_{\theta_{TRUE}}(C = 1|W = w)$$

**Bayes optimal classifier (with reject option):**

$$y_{\theta_{TRUE}}^*(w) = \begin{cases} 1 & \text{if } \eta(w) > 1 - d \\ 0 & \text{if } \eta(w) < d \\ \text{abstain} & \text{otherwise, i.e., } d \leq \min\{\eta(w), 1 - \eta(w)\} \end{cases}$$

where  $d \in [0, 1/2]$  is the reject cost.

► If  $y_{\theta_{TRUE}}^*(w) \neq \text{abstain}$

*[d upper bound on misclassification error]*

$$d \geq P(y_{\theta}^*(w) \neq C) = \min\{\eta(w), 1 - \eta(w)\}$$

**Theorem (Chow 1970).**

$$\arg \min_{y_{\theta}^+} E_{(W,C) \sim f_{\theta_{TRUE}}} [d \mathbb{1}_{y_{\theta}^+(W) = \text{abstain}} + \mathbb{1}_{y_{\theta}^+(W) \neq C, y_{\theta}^+(W) \neq \text{abstain}}] = y_{\theta_{TRUE}}^*$$

# Selective binary classification

A *selective binary classifier* (score) is a pair  $(s_\theta, g_\theta)$ , where  $s_\theta()$  is a classifier (score) and  $g_\theta : \mathbb{R}^{|W|} \rightarrow \{0, 1\}$  is a *selection function*, which determines when to accept/abstain from using  $s_\theta$  as follows:

$$(s_\theta, g_\theta)(w) = \begin{cases} s_\theta(w), & \text{if } g_\theta(w) = 1 \\ \text{abstain}, & \text{otherwise} \end{cases}$$

## Support and Risk

The *coverage* of a selective classifier is  $\phi(g_\theta) = E_{(W,C) \sim f_{\theta, \text{TRUE}}} [g_\theta(W)]$ , i.e., the expected probability of the accepted region.

The risk w.r.t. a loss function  $\ell_\theta$  is  $R(s_\theta, g_\theta) = E_{(W,C) \sim f_{\theta, \text{TRUE}}} [\ell_\theta(C, W)g_\theta(W)] / \phi(g_\theta)$ .

- Empirical coverage and empirical selective risk:

$$\hat{\phi}(g_\theta) = \frac{\sum_{i=1}^n g_\theta(w_i)}{n} \quad \hat{r}(s_\theta, g_\theta) = \frac{\frac{1}{n} \sum_{i=1}^n \ell_\theta(c_i, w_i) g_\theta(w_i)}{\hat{\phi}(g_\theta)}$$

- *Selective classification problem*: minimize risk while guaranteeing a minimum support  $c$

$$\arg \min_{\theta} R(s_\theta, g_\theta) \quad \text{s.t.} \quad \phi(g_\theta) \geq c$$

# Selective binary classification

A *selective binary classifier* (score) is a pair  $(s_\theta, g_\theta)$ , where  $s_\theta()$  is a classifier (score) and  $g_\theta : \mathbb{R}^{|W|} \rightarrow \{0, 1\}$  is a *selection function*, which determines when to accept/abstain:

$$(s_\theta, g_\theta)(w) = \begin{cases} s_\theta(w), & \text{if } g_\theta(w) = 1 \\ \text{abstain}, & \text{otherwise} \end{cases}$$

- Soft selection:  $g_\theta(w) = 1$  iff  $k_\theta(w) \geq \tau$  where  $k_\theta(w)$  is a *confidence function*
  - ▶ A good confidence function should rank instances based on descending loss, i.e., if  $k(w) \leq k(w')$  then  $E[\ell_\theta(C, w)] \geq E[\ell_\theta(C, w')]$ .
  - ▶ E.g., confidence of the classifier:  $k_\theta(w) = \min\{s_\theta(w), 1 - s_\theta(w)\}$
- The inherent trade-off between risk and coverage is summarized by the *risk-coverage curve*

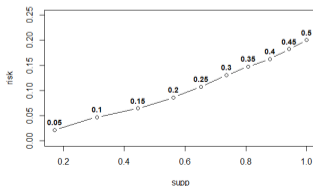

See R script